

1. APPLICATION

Fluorescent Lamp、Electronic Ballast、
 Charger and Switch-mode power supplies

2. FEATURES

- High voltage capability
- Features of good high temperature
- High switching speed

3. PACKAGE

TO-220

4. Electrical Characteristics

4.1 Absolute Maximum Ratings

$T_{amb}=25^{\circ}\text{C}$ unless specified

PARAMETER		SYMBOL	VALUE	UNIT
Collector-Base Voltage		V_{CBO}	700	V
Collector-Emittor Voltage		V_{CEO}	400	V
Emittor- Base Voltage		V_{EBO}	9	V
Collector Current		I_C	4	A
Power Dissipation	$T_a=25^{\circ}\text{C}$	P_{tot}	2	W
	$T_c=25^{\circ}\text{C}$		65	
Junction Temperature		T_j	150	$^{\circ}\text{C}$
Storage Temperature		T_{stg}	-55~150	$^{\circ}\text{C}$

4.2 Electrical Parameter

$T_{amb}=25^{\circ}\text{C}$ unless specified

PARAMETER	SYMBOL	TEST CONDITION	VALUE			UNIT
			MIN	TYP	MAX	
Collector-Base Voltage	BV_{CBO}	$I_C=1\text{mA}, I_E=0$	700			V
Collector-Emittor Voltage	BV_{CEO}	$I_C=1\text{mA}, I_B=0$	400			V
Emittor-Base Voltage	BV_{EBO}	$I_E=1\text{mA}, I_C=0$	9			V
Collector-Base Cutoff Current	I_{CBO}	$V_{CB}=700\text{V}, I_E=0$			10	μA
Collector-Emittor Cutoff Current	I_{CEO}	$V_{CE}=400\text{V}, I_B=0$			20	μA
Emittor-Base Cutoff Current	I_{EBO}	$V_{EB}=9\text{V}, I_C=0$			10	μA
DC Current Gain	h_{FE}^*	$V_{CE}=5\text{V}, I_C=1\text{mA}$	8			
		$V_{CE}=5\text{V}, I_C=1\text{A}$	15		30	
Collector-Emittor Saturation Voltage	$V_{CE\text{ sat}}^*$	$I_C=2\text{A}, I_B=1\text{A}$			0.6	V
Base-Emittor Saturation Voltage	$V_{BE\text{ sat}}^*$	$I_C=2\text{A}, I_B=1\text{A}$			1.2	V
Rising Time	t_r	$I_C=500\text{mA} \quad (UI9600)$			0.8	μs
Falling Time	t_f				0.6	μs
Storage Time	t_s		2.0		4.0	μs
Typical Frequency	f_T	$V_{CE}=10\text{V}, I_C=0.1\text{A}, f=1\text{MHz}$	5			MHz

*: Pulse test $t_p \leq 300 \mu\text{s}, \delta \leq 2\%$

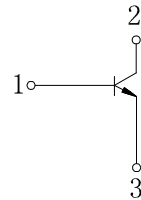

1 Base(B) 2 Collector(C) 3 Emitter(E)

5. Characteristic Curve

Fig1 SOA (DC)

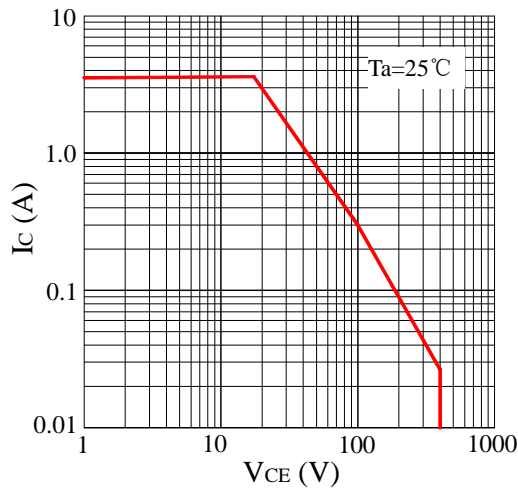

Fig2 Ptot - T

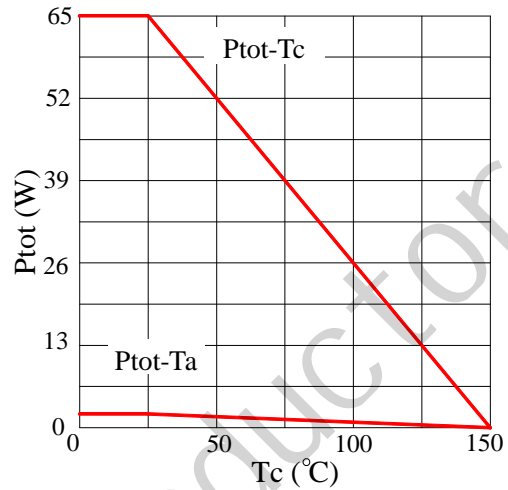

Fig3 Static Characteristic

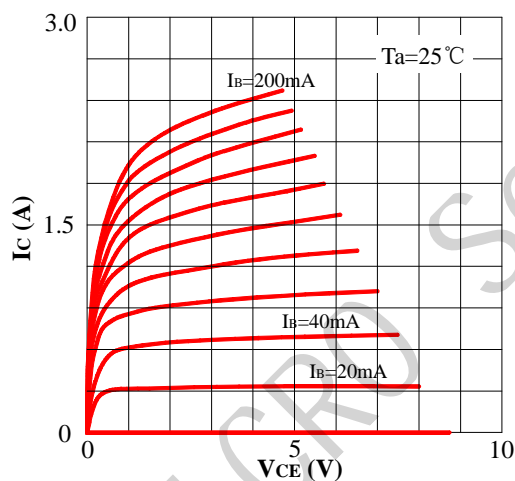

Fig4 hFE-Ic

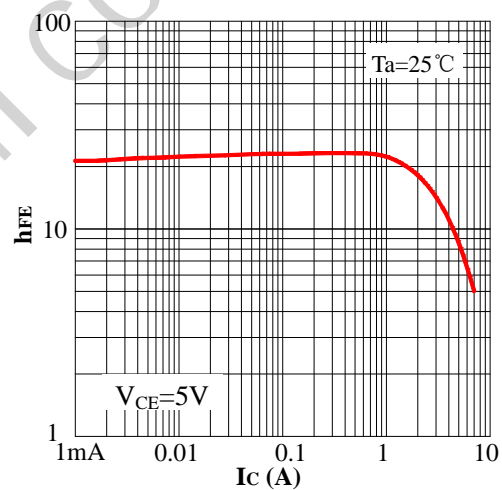

Fig5 VCESat-Ic

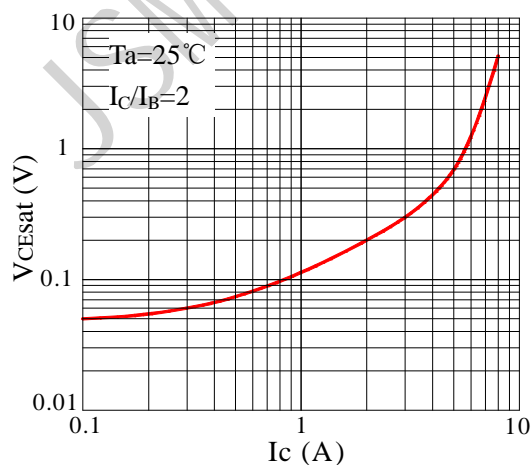
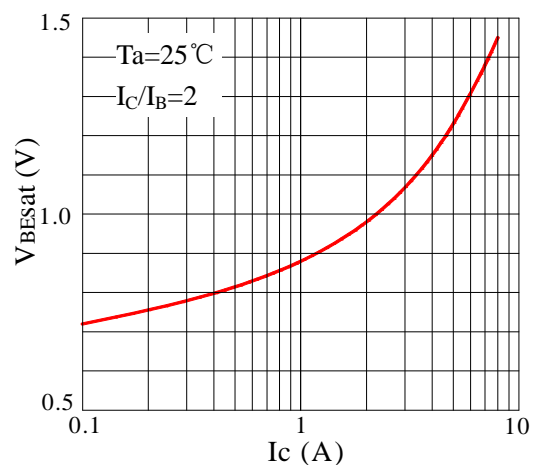

Fig6 VBESat-Ic



6. Package Dimentions(Unit: mm)

TO-220

单位: mm

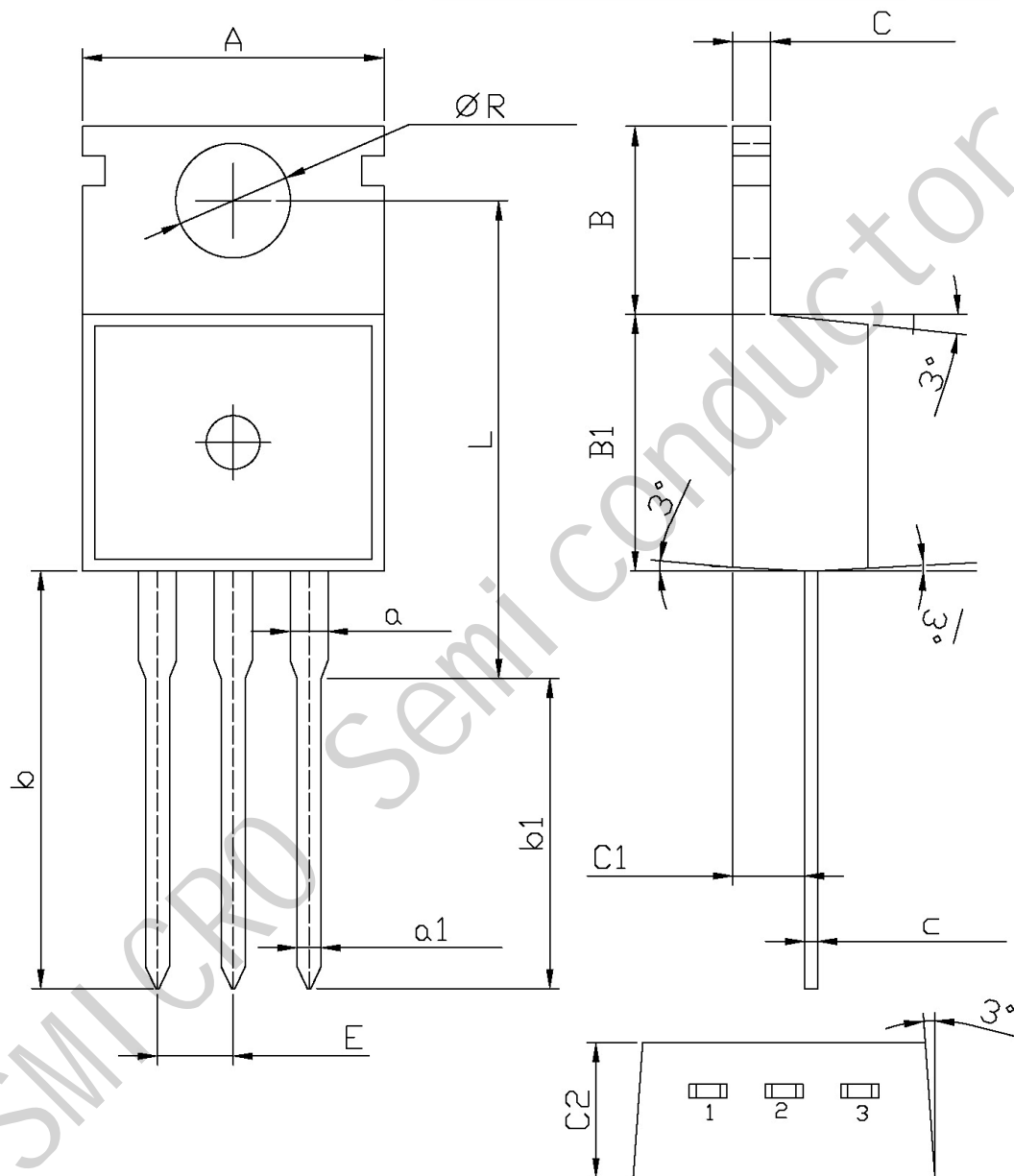

Symbol	Dimensions In Millimeters		Symbol	Dimensions In Millimeters	
	Min	Max		Min	Max
A	9.8	10.2	C	1.2	1.4
R	3.56	3.64	B	6.3	6.7
L	15.7	16.1	B1	9.0	9.4
b	12.6	13.6	C1	2.2	2.6
b1	9.6	10.6	a1	0.7	0.9
a	1.22	1.32	c	0.4	0.6
E	2.34	2.74	C2	4.3	4.7